

CENTURY II Performing Arts & Cultural Center

Wichita's 100 Year Centennial Celebration



In Wichita's Early Days....



*Ford at Douglas & River
1872*

Toll Bridge over Arkansas River 1872
Indians Fording River
From Collection of John P. Davidson

In 1961 Wichita Citizens Voted!

Architect Roy Varenhorst & Mayor Vince Bogart



Total Cost \$12,600,000

- Voted for by Wichita Citizens
- Paid for by City Bonds
- Bid on by Architects and Contractors
- Municipal Building owned by Wichita Citizens

Overhead Section - Circular Shape

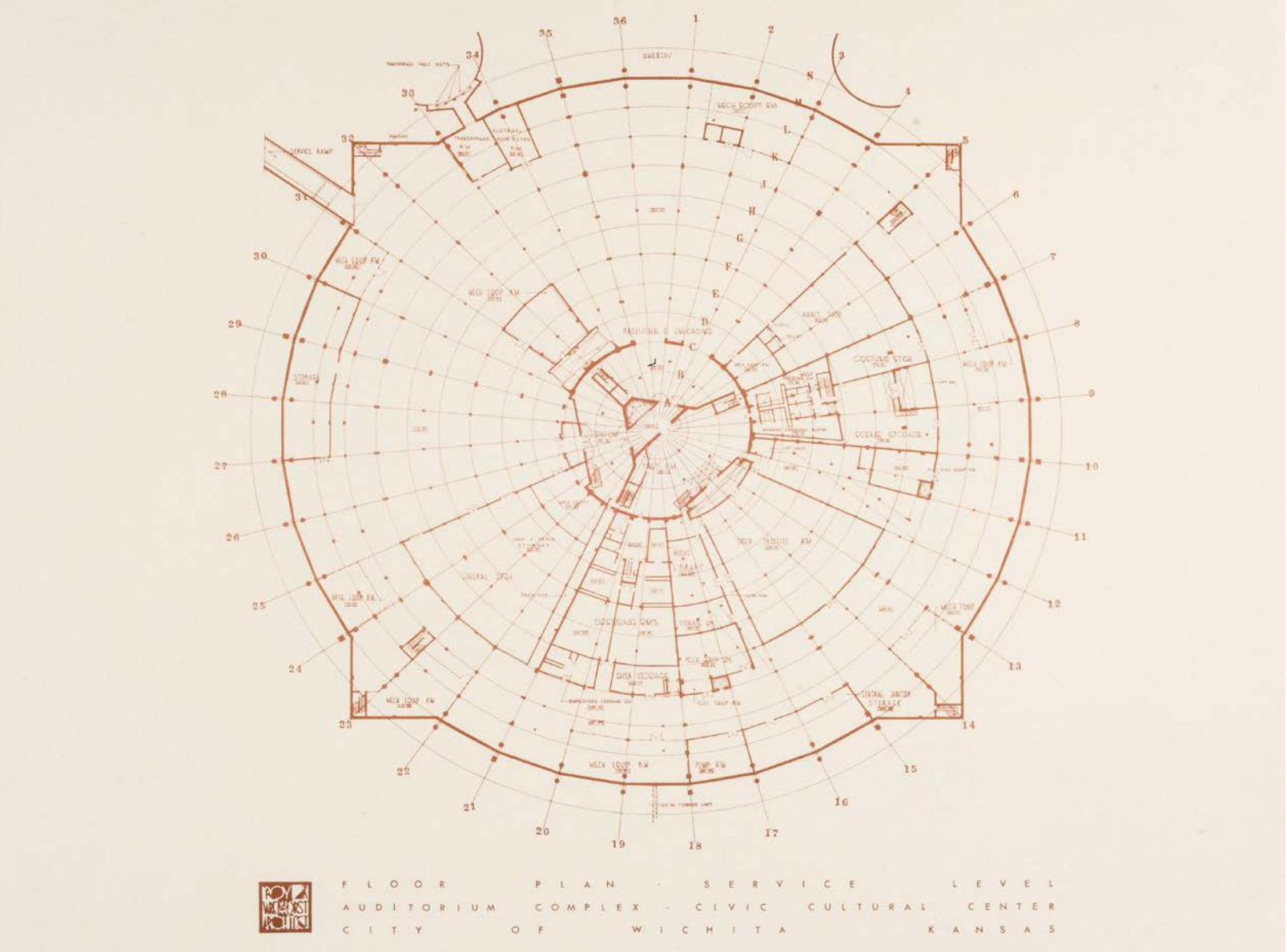

Cross Section – Mary Jane Teall Theatre

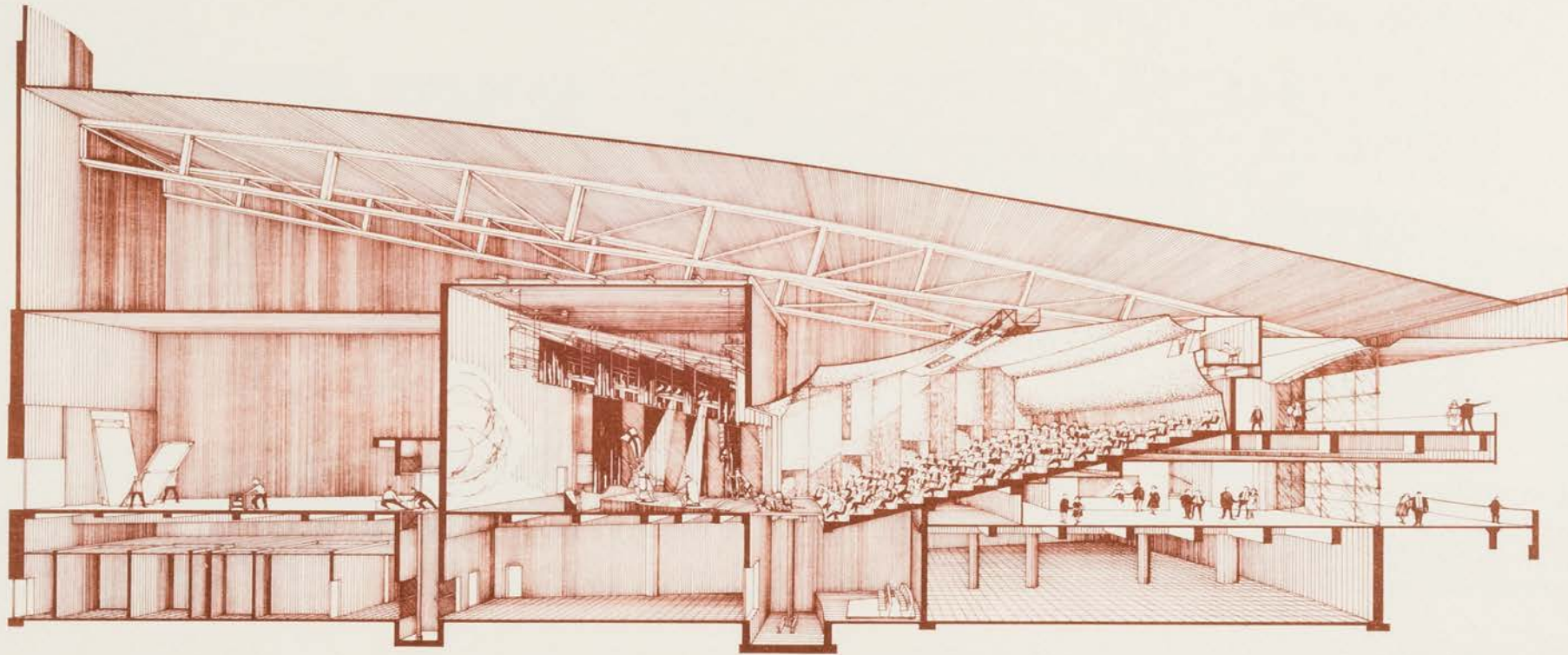

SECTION PERSPECTIVE -
AUDITORIUM COMPLEX - CIVIC
CITY OF WICHITA

T H E A T R E
C U L T U R A L C E N T E R
K A N S A S

Construction began in 1966

Architect John Hickman



Concrete Core



Strong Steel Ribbing

15-Ton Steel Trusses Each 217 Feet Long



25 Railcars of Plaster from Sun City, Kansas

National Gypsum Company – Hand Tried by Plasterers

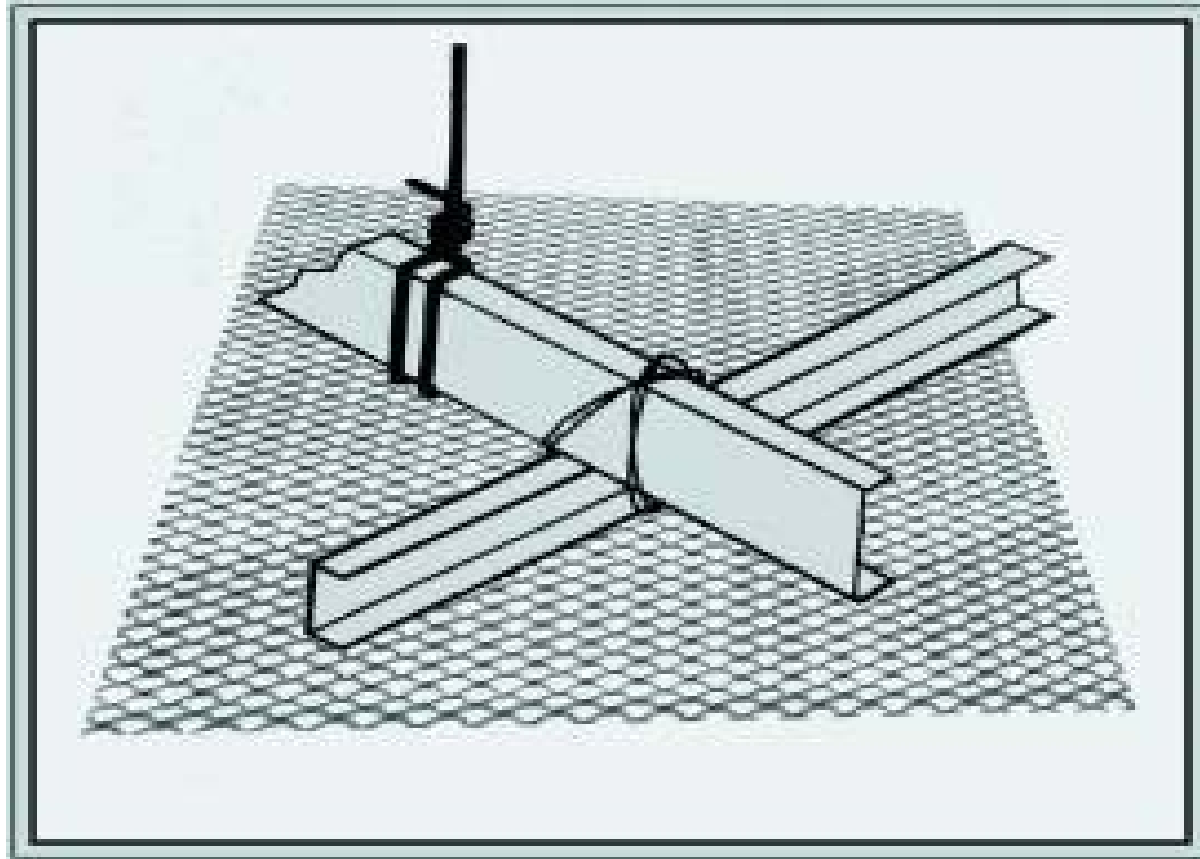

Grand Opening January 1969

THE NOTION THAT "CULTURE" IS A LUXURY PERSISTS IN THE MINDS OF THOSE THAT DO NOT REALIZE THAT CULTURE IS THE BEST OF WHAT WE ARE AND WHAT WE HOPE TO BECOME. THE CULTURAL ENTERPRISE CONSISTS OF EXHIBITING AND DISPLAYING THOSE QUALITIES WHICH ARE SIGNIFICANT, INSTRUCTIVE, ENTERTAINING, ATTRACTIVE AND WHICH ADD TO OUR APPRECIATION OF THE PLACE IN WHICH WE LIVE AND WORK.

Roy K. Wrenhorst



Blue Roof for the Kansas Sky



Sand Colored Columns for Wheat



Wichita's Unique Skyline



Century II Is Worth Preserving!!!!

- **Triple Historic Designation** – Local, State and National
- **Mid Century Modern Structures** – Garvey Center & Brutalist Former Public Library
- **Frank Lloyd Wright Buildings** – WSU Corbin & Allen House
- **Hickman Buildings** – Vickers Gas Station & KG&E
- **Downtown** – Carnegie Library (1915), Sedgwick County Historical Museum (1890) & Broadview Hotel (1920)

Mary Jane Teall Theatre



Concert Hall



Concert Hall Main Floor & Balcony

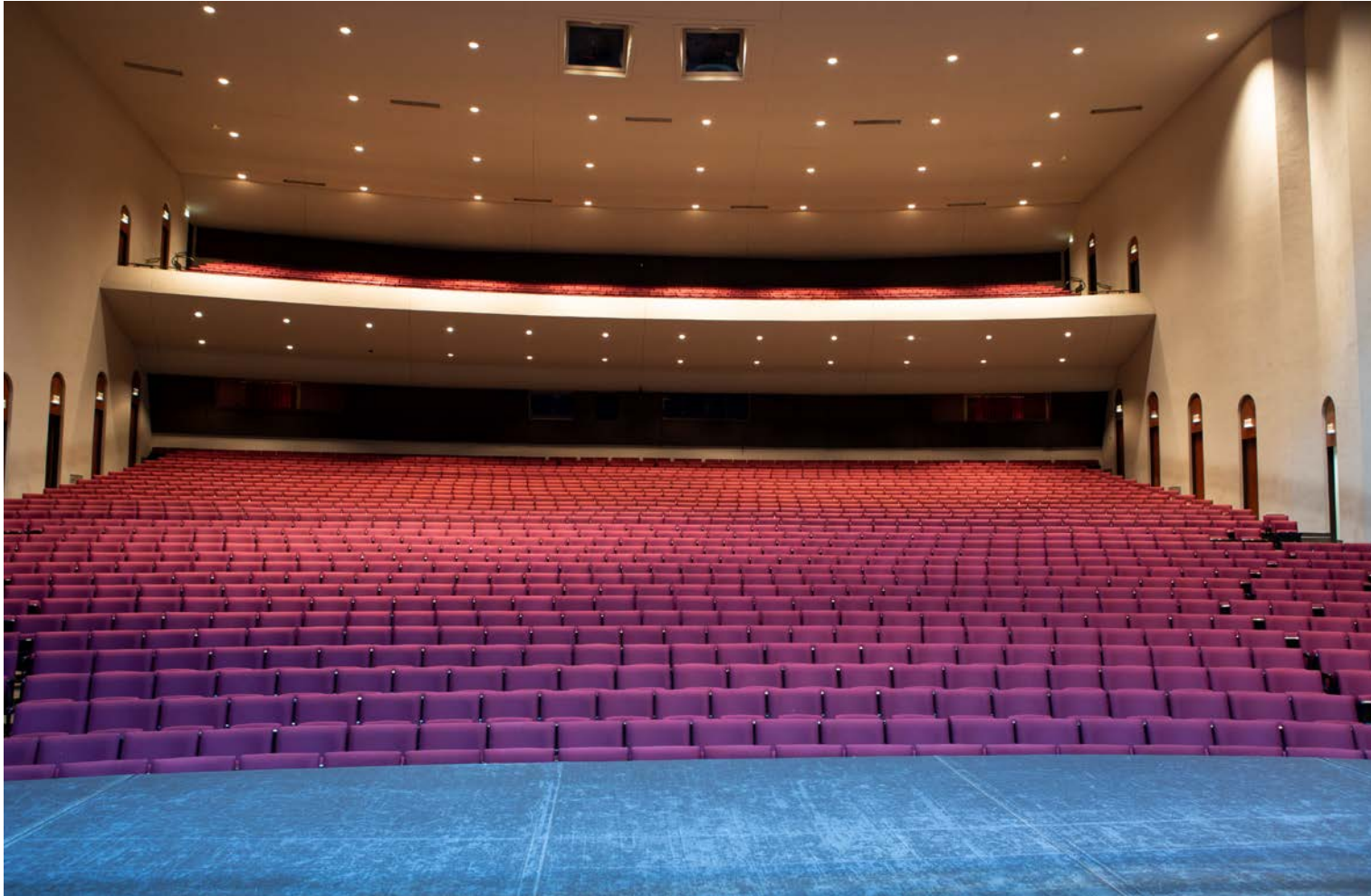

Convention Hall

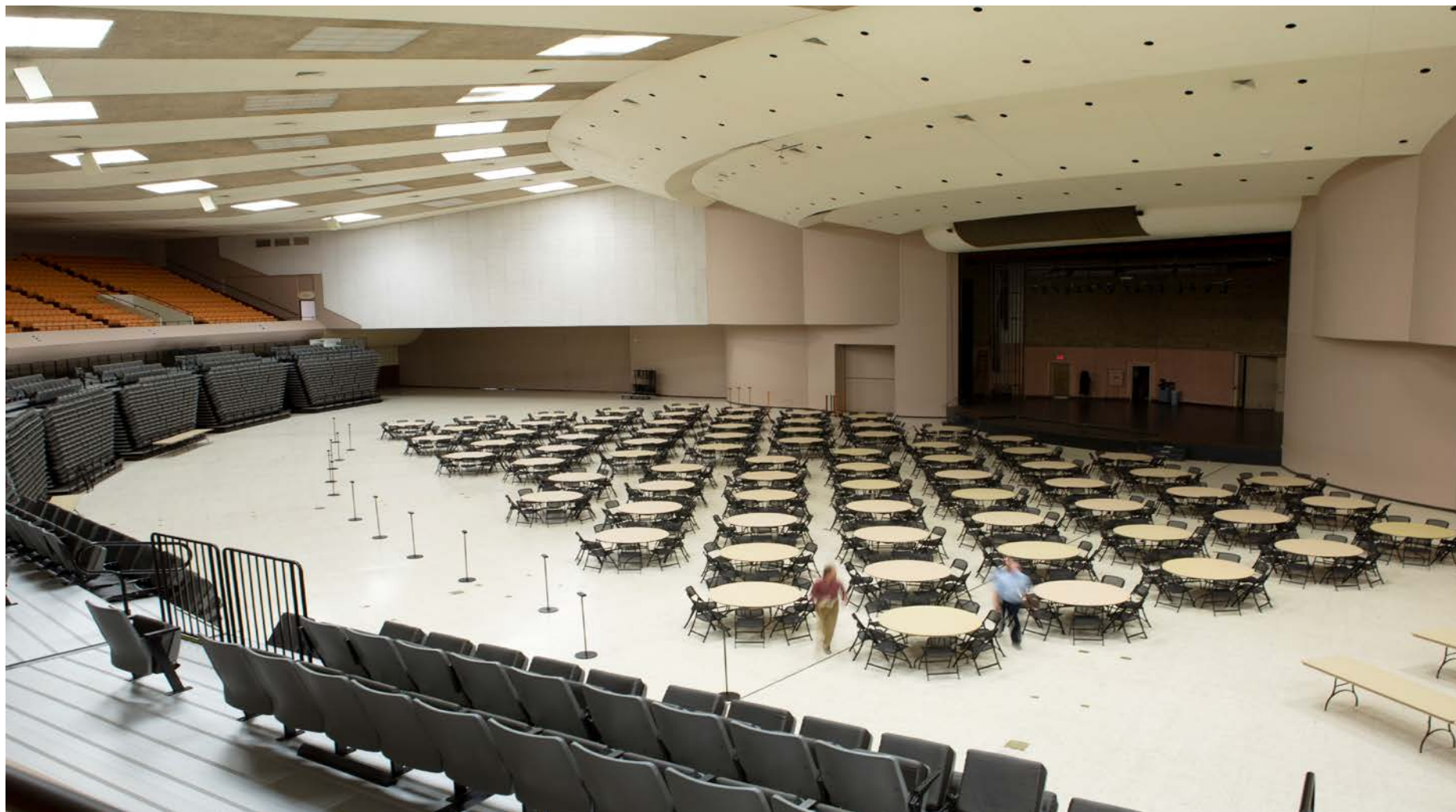

Exhibition Hall



Website www.savec2.org & Fund Raising

SAVE CENTURY II

T SHIRT ORDER FORM

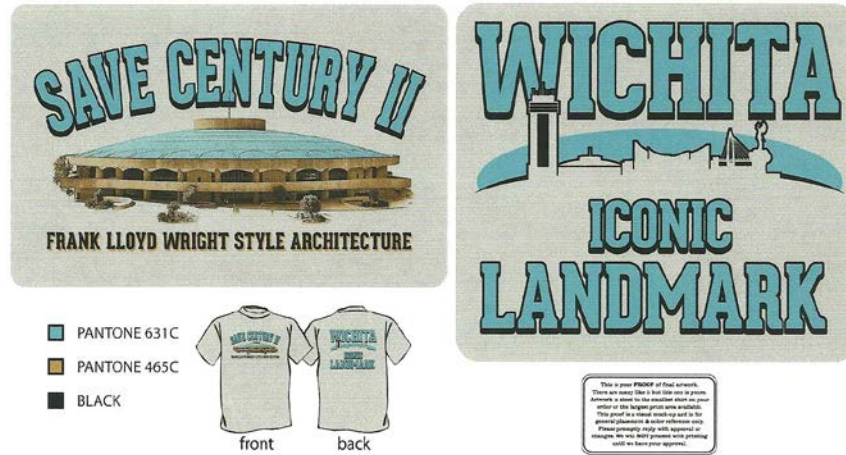

The image shows two design options for a t-shirt. The first design features the text 'SAVE CENTURY II' in a stylized, arched font above a detailed illustration of the Century II arena, with the text 'FRANK LLOYD WRIGHT STYLE ARCHITECTURE' below it. The second design features the word 'WICHITA' in a large, blocky font above a silhouette of the city skyline, with 'ICONIC LANDMARK' below it. To the left of these designs are color swatches for 'PANTONE 631C' (teal), 'PANTONE 465C' (yellow), and 'BLACK'. Below the swatches are two small t-shirt icons labeled 'front' and 'back'. A small disclaimer box at the bottom right of the design area reads: 'This is your PROOF of final artwork. There are many files to look over in print. Items are sent to the printer as soon as possible. This proof is not a final proof and is not a guarantee of color reproduction. Please promptly notify with approval or changes. We will hold payment until payment is received.' A legend below the swatches indicates: ■ PANTONE 631C, ■ PANTONE 465C, ■ BLACK.

The Historic Preservation Alliance, Inc. is raising money to Save Century II by renovating and/or repurposing the structure. Light grey t-shirts are being offered for donations of \$20.00 or more. Unisex sizes include M, L, XL, and XXL. Please complete the order form below and mail in your \$20.00 donation today! You will receive your t-shirt in the mail. Quantities are limited so order now! Make check payable to Historic Preservation Alliance, Inc. Please add \$5 to your order for shipping costs.

Customer Name _____

Customer Address _____

Customer Email _____ Phone Number _____

Size Ordered: _____M _____L _____XL _____XXL

Send your check or money order to:

Historic Preservation Alliance, Inc.

P. O. Box 75037

Wichita, Kansas 67275



Public Meetings

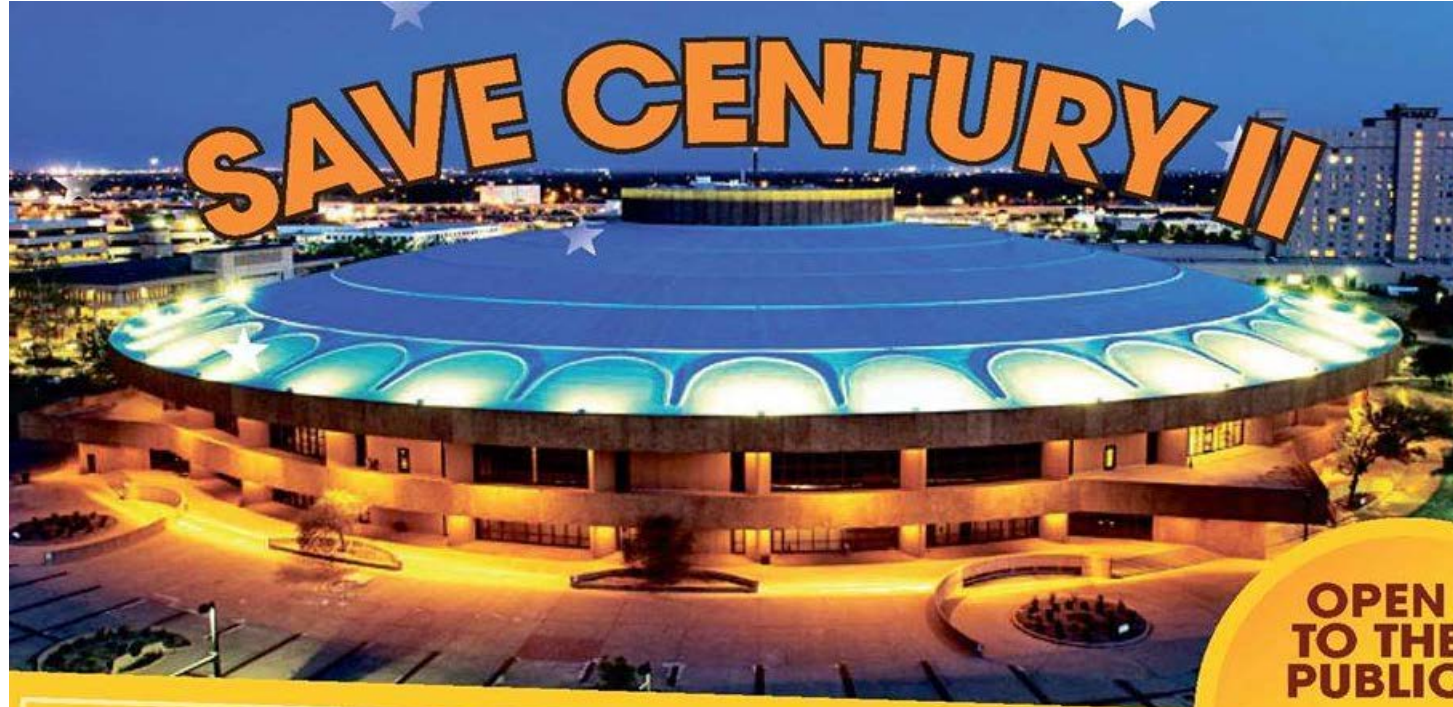

SAVE CENTURY II



FRANK LLOYD WRIGHT STYLE ARCHITECTURE

**MARY JANE TEALL
THEATRE AT CENTURY II**



**October 22nd,
Tuesday 5:30-7:00 p.m.**

*Guest Panel to include
Bill Warren, Ann Garvey
and a special guest!*

Wonderful Volunteers!



Public Voter Rally and Interviews



Municipal Petition Drive to Require a Vote

**OPEN TO
THE PUBLIC**

Final Voter Rally at Park Villa

**July 8, Wednesday 6:00-8:00 p.m.
1029 N. Bitting, Riverside**

**Family activities and light refreshments.
Buttons, yard signs and T-shirts available.**



Time has run out, sign NOW!!! ★

Drive by petition signing on 9th street.

Stay in your car and we'll be COVID safe with masks and hand sanitizer as you sign the petition.

Help us Save Century III!!! ★

This is the last chance to sign a petition.

Be part of Wichita history by bringing this to a vote - your voice is important.

Paid for by the Save Century II Committee

Wichita Registered Voter Petition

PETITION TO THE GOVERNING BODY OF THE CITY OF WICHITA, KANSAS
Pursuant to Applicable Kansas Law

Shall the following ordinance become effective:

BE IT ORDAINED THAT THE GOVERNING BODY OF THE CITY OF WICHITA, KANSAS:

No prominent city owned buildings of historical importance or architectural significance (regardless of historic register status), including Century II and the adjoining former Public Library, shall be demolished, replaced or otherwise adversely affected without a public vote of approval by the qualified voters in the City of Wichita, and further, no interest in such city owned buildings, including Century II and the adjoining former Public Library, shall be leased, sold, bartered, traded, conveyed or assigned and thereafter demolished, replaced or otherwise adversely affected without a public vote of approval by the qualified voters in the City of Wichita.

I have personally signed this petition.

I am a registered elector of the State of Kansas and the City of Wichita, County of Sedgwick, and my residence address is correctly written after my name.

#	Date	Signature	Printed Name	Printed Address
1				Wichita, KS
2				Wichita, KS
3				Wichita, KS
4				Wichita, KS
5				Wichita, KS
6				Wichita, KS
7				Wichita, KS
8				Wichita, KS
9				Wichita, KS
10				Wichita, KS

State of Kansas)
) ss:
County of Sedgwick)

I am the circulator of this petition and a resident of the State of Kansas and possess the qualifications of an elector of the State of Kansas. I have personally witnessed the signing of the petition by each person whose name appears thereon. I believe the statements made herein and that each signature appended to the paper is the genuine signature of the person whose name it purports to be.

Signature of Circulator

Circulator's Residence Address

Signed and sworn to before me this ____ day of _____, 2020, by _____
Circulator Print Name

My appointment expires: _____

Notary Public

People Joined In to Help

- 17,265 Petition Signatures!!!
- Petition Lawsuit Filed by City
- Appeal Pre-funded



This is Our Heritage – It Matters

Wichita, My Son

Frances BlackBear Bosin – Keeper of the Plains



